

AL40-R

Smart, elegant lighting for all marine ceilings



Meet the new Glamox AL40-R

A recessed indoor luminaire developed for marine and offshore environments. It is both a robust and aesthetically pleasing luminaire, developed for life at sea.



A modern and environmentally friendly solution

The AL40 is the first choice for new-build vessels. It is an environmentally friendly LED luminaire that fits nearly all marine ceilings and is easy to install. All AL40-R product versions are approved for B0, and B15 for use with extra insulation.

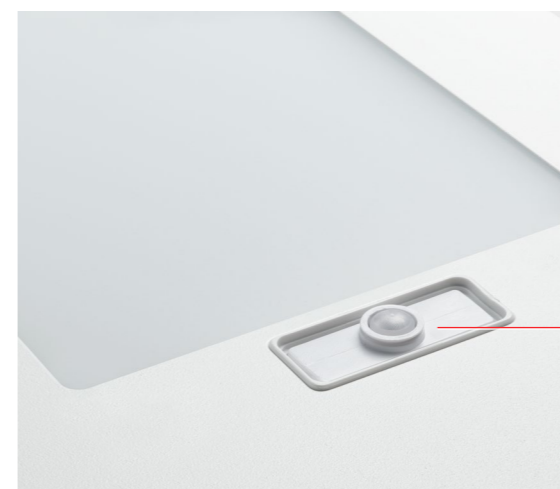

With integrated sensors and the option for use with both Glamox Connect and Dali 2, AL40-R can easily be integrated into your existing or future LMS solution.





Great for social areas

AL40-R is constructed to provide comfortable and glare-free lighting in locations where people – both crew and passengers, spend their time.



This includes offices, cabin corridors, staircases, crew cabins, control rooms, and the bridge. On an offshore rig, the AL40-R is perfect for areas like the

gym, locker rooms, mess rooms, crew areas, and public areas. It is both a robust and aesthetically pleasing luminaire, developed for life at sea.

Marine approved

AL40-R (M) is delivered with a marine-approved driver. This means that it is vibration resistant for use in rougher environments such as offshore supply and fishing vessels.

All AL40-R product versions are approved for B0, and B15 for use with extra insulation.



AL40-R GP (M) with integrated emergency

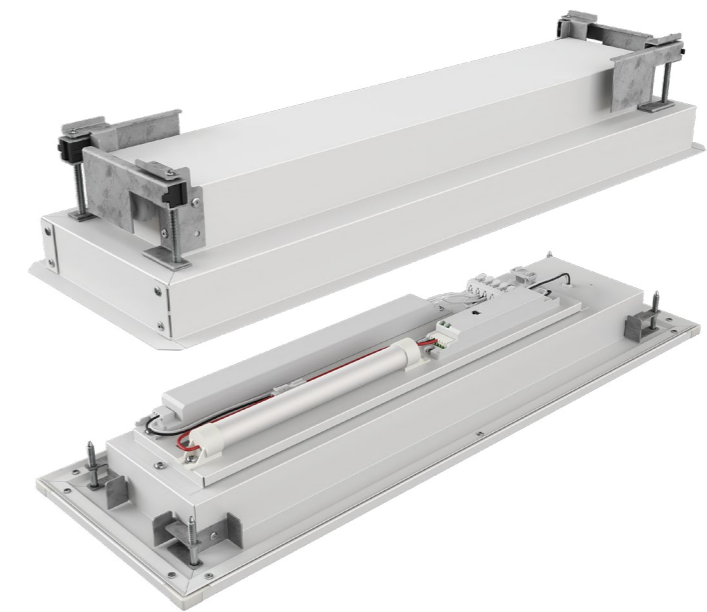

Options available

We know that some markets require different installation options for their luminaires. This is why the AL40-R is available in both Compact and Glamox Platform (GP) versions, where the latter is easier to upgrade with removable cassette, and features extra room for larger cables.

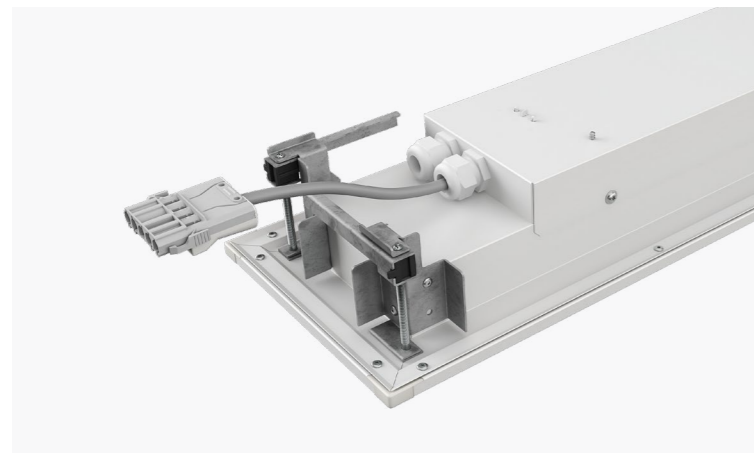

Compact version

Glamox Platform version



Measurement drawings

AL40-R 680 x 220

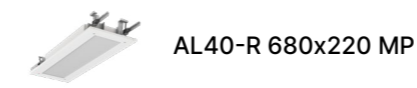
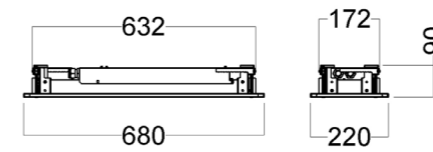

AL40-R 680x220 MP

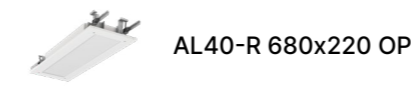

AL40-R 680x220 OP

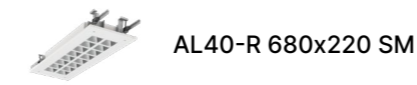

AL40-R 680x220 SM

AL40-R GP 680 x 220

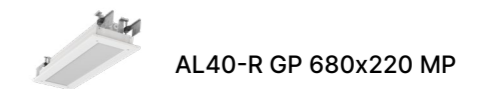
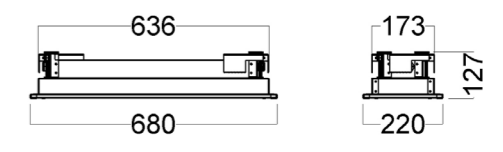

AL40-R GP 680x220 MP

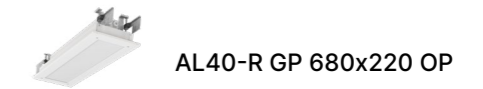

AL40-R GP 680x220 OP

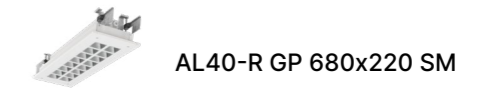

AL40-R GP 680x220 SM

AL40-R 960 x 220

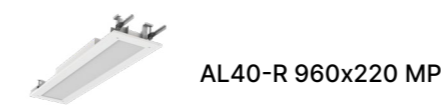
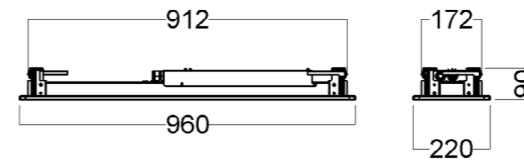

AL40-R 960x220 MP

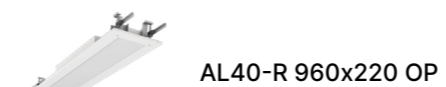

AL40-R 960x220 OP

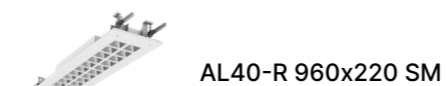

AL40-R 960x220 SM

AL40-R GP 960 x 220

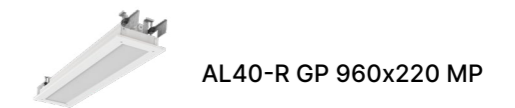
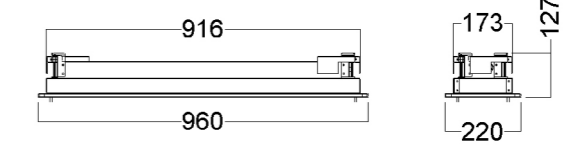

AL40-R GP 960x220 MP

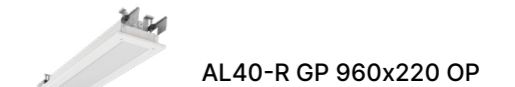

AL40-R GP 960x220 OP

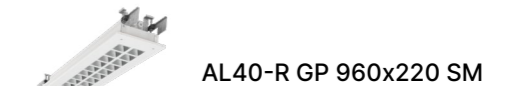

AL40-R GP 960x220 SM



AL40 MP
Emergency

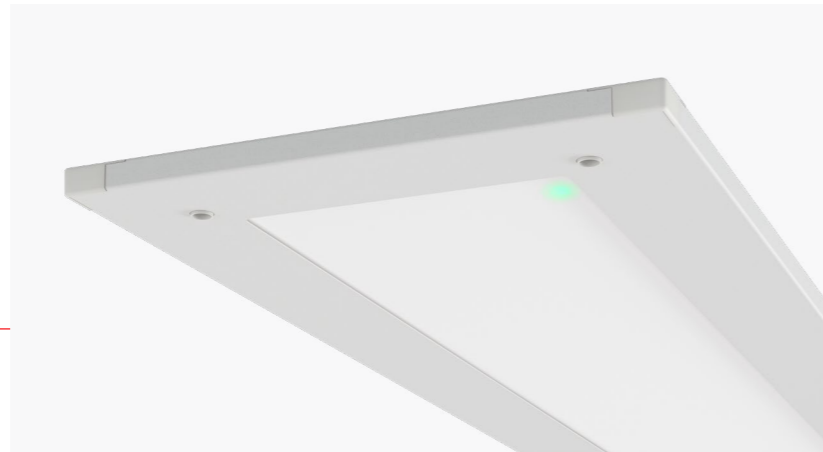

AL40 OP
Emergency



Opal (OP/PC)
- Basic option



Micro Prismatic (MP/PC)
- Office and control room
- Better UGR



Silver Matt Reflectors (SM)
- Architectural areas
- Higher light output
- Best UGR

Item list

Description	Driver	Emergency	Color temp.	Sensor	Optics	Fire rating	Connection
AL40-R (M) 220×680	HF	EB3/S	830	SMR-SEN	OP/MP/SMR	B0	2XQCA
AL40-R (M) 220×960	HF	EB3/S	830	SMR-SEN	OP/MP/SMR	B0	2XQCA
AL40-R (M) 220×680	DALI	EB3/S	830		OP/MP/SMR	B0	2XQCA
AL40-R (M) 220×960	DALI	EB3/S	830		OP/MP/SMR	B0	2XQCA
AL40-R (M) GP 220×680	HF	E3/S EB3/S	830	SMR-SEN	OP/MP/SMR	B0	4XM24 (2G/2B)
AL40-R (M) GP 220×960	HF	E3/S EB3/S	830	SMR-SEN	OP/MP/SMR	B0	4XM24 (2G/2B)
AL40-R (M) GP 220×680	DALI	E3/S EB3/S	830		OP/MP/SMR	B0	4XM24 (2G/2B)
AL40-R (M) GP 220×960	DALI	E3/S EB3/S	830		OP/MP/SMR	B0	4XM24 (2G/2B)

Some combinations may not be possible (e.g. DALI+ Emergency+ Sensor) please get in touch with our team for more information.

Links

[See all R \(M\) versions →](#)

[See all GP \(M\) versions →](#)

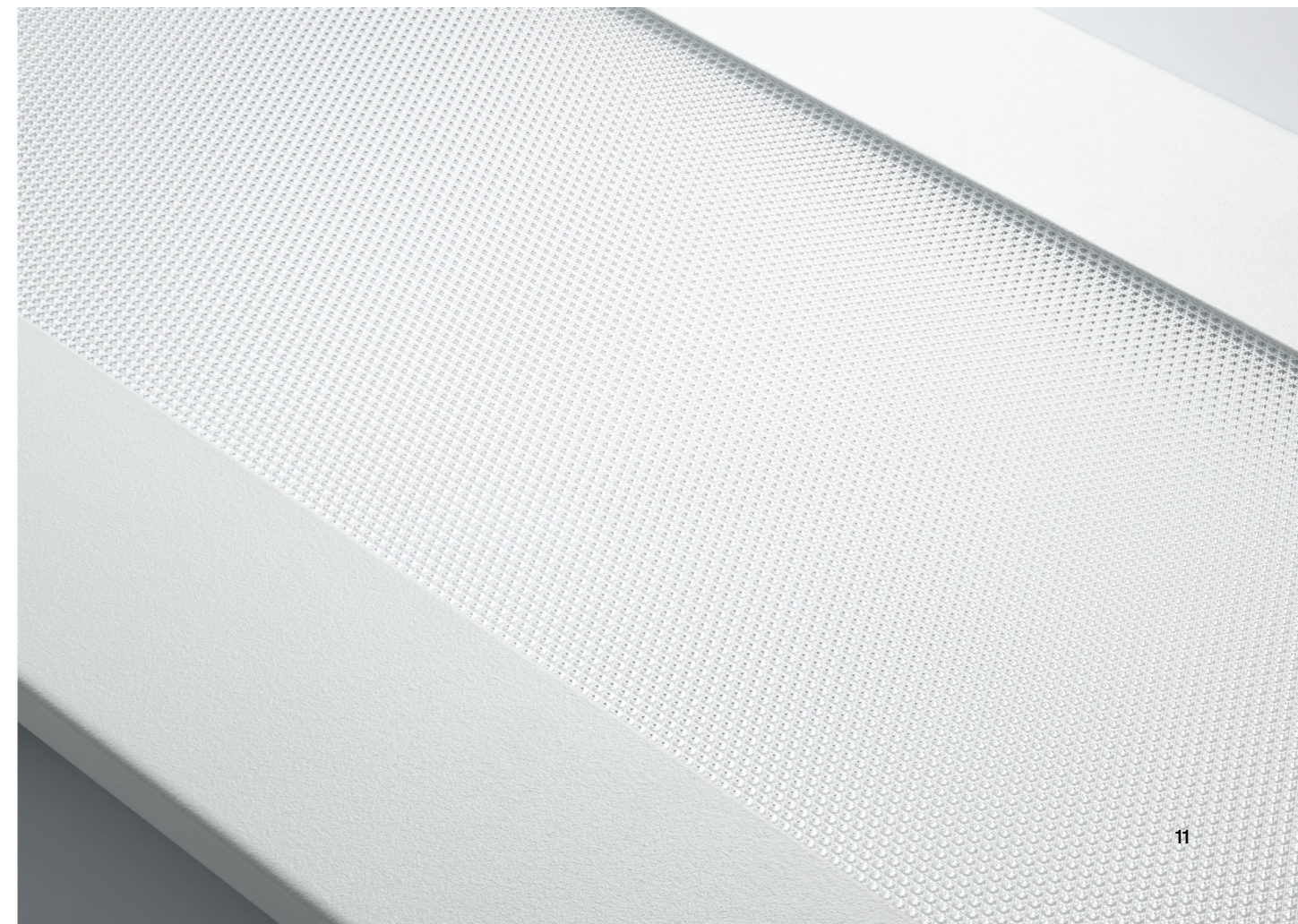

The Glamox Group

Glamox is a Norwegian industrial group that develops, manufactures and distributes professional lighting solutions for the global market.

Quality brands and solutions

The Group owns a range of quality lighting brands including Glamox, Aqua Signal, Luxo, Norselight, LINKSrechts and Küttel. Glamox is committed to meeting customer needs and expectations by providing quality products and solutions, service and support.

Technology and expertise

Our products and solutions are developed and tested by our engineers at our own research and testing facilities, and manufactured and certified in accordance with all relevant quality and environmental standards. They are based on the latest technology and expertise – and generations of experience.

For more info, see www.glamox.com

