



Fuel Consumption System

Coriolis mass flow meter based real-time
fuel consumption monitoring

MARINE

Fuel efficiency is the key to savings

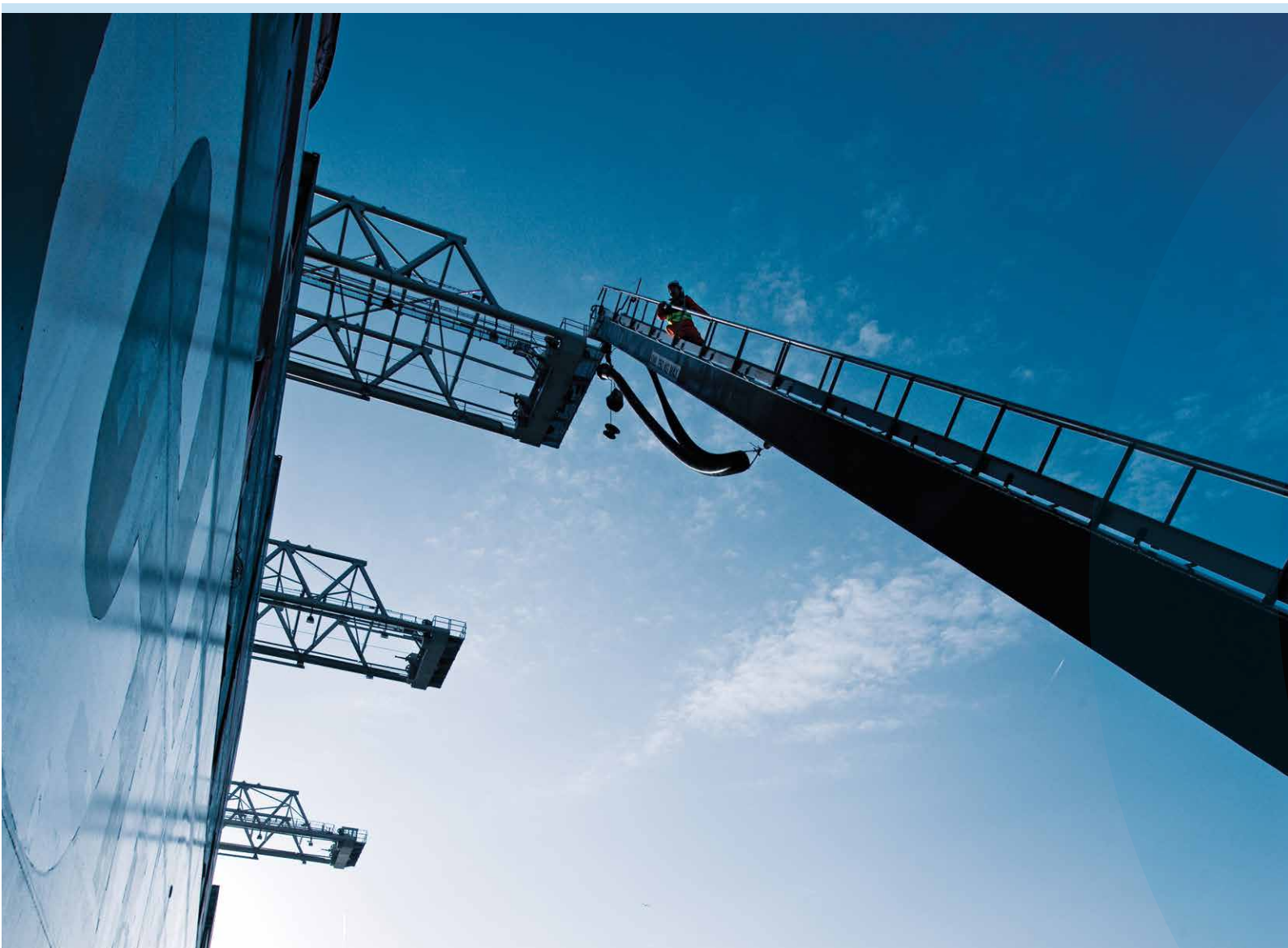

*Insatech – taking the guesswork out of it!
Get an overview of your fuel consumption and improve it.
Don't use guess work when you can – act on knowledge*



The system provides cost efficient, real-time, and accurate insight of fuel consumption. Mass flow meters measure the vessel's general performance and efficiency, when transforming costly bunker fuel into propulsion. With knowledge of your operation you are equipped to change performance for the better.



Introduction

An increase in environmental regulations, fluctuating bunker prices, and increased competition, means smaller profit margins in the shipping industry, and an increased focus on performance and efficiency. Fuel costs constitute a major part of a vessel's operating costs, so getting insight into the costs with the Fuel Consumption System makes good business sense.

4



How It Works

The Fuel Consumption System uses Coriolis Mass Flow Meters to measure the flow in the fuel system. Measuring directly in mass and not volume, gives high accuracy and eliminates risk of errors in conversion from litres to kg. The system may be setup in different ways depending on the level of insight wanted or if you should have specific requirements.

6



Operation

The system is fully automated. Collection of data from flow meters and calculations of fuel consumption provides you with an instant overview of the vessel's consumers via a display which can be placed at your preferred location. The display is easy to read, operated by touch, and is easily navigated.

8



Fuel Consumption in detail

Get an overview of the fuel consumption system, the instruments it contains and the signals it uses, as well as our modular performance concept made to suit your current and future measurement and management needs.

12



Installation

The system is delivered fully calibrated. During a typical installation the vessel's crew will install the equipment under the guidance of Insatech Marine technicians to ensure correct placement and connection.

16



Service and Support

The Fuel Consumption System does not have any moving parts and therefore the need for active maintenance is minimal. However should problems arise Insatech Marine technicians are ready to perform both scheduled and un-scheduled service and repair at your preferred location.

19



Contacts World Wide

Insatech Marine has a broad and international agent network, spanning from Finland to India. We want to serve you in the best possible way, and our agents are ready to receive your inquiries and questions. Find your local representative to learn more about our solutions or go to www.insatechmarine.com

22

Introduction



Operational efficiency in shipping is a condition for staying in business. Increasing crew awareness and knowledge of accurate fuel consumption is key to getting the most out of improvement projects and new procedures. And measurement accuracy is the cornerstone of securing the added profit when optimising the operation.

Maritime operation requires a high degree of attention towards operational efficiency and awareness on board vessels, both as a way to reduce costs but also due to legal and environmental requirements. Knowing your operation and basic consumption is a prerequisite for being able to determine fluctuations, and identify if/why an increased consumption has occurred. It is also important to know basic consumption when optimizing via performance improving investments in systems or equipment.

Since 50% – 70% of OPEX (Operating Expenses) is constituted by the cost of fuel, always knowing actual fuel consumption is worth your while. Add to the fuel cost the continuously increasing requirement regarding environmental issues; documenting your vessel's number one contributor to emissions – the fuel – via an automated

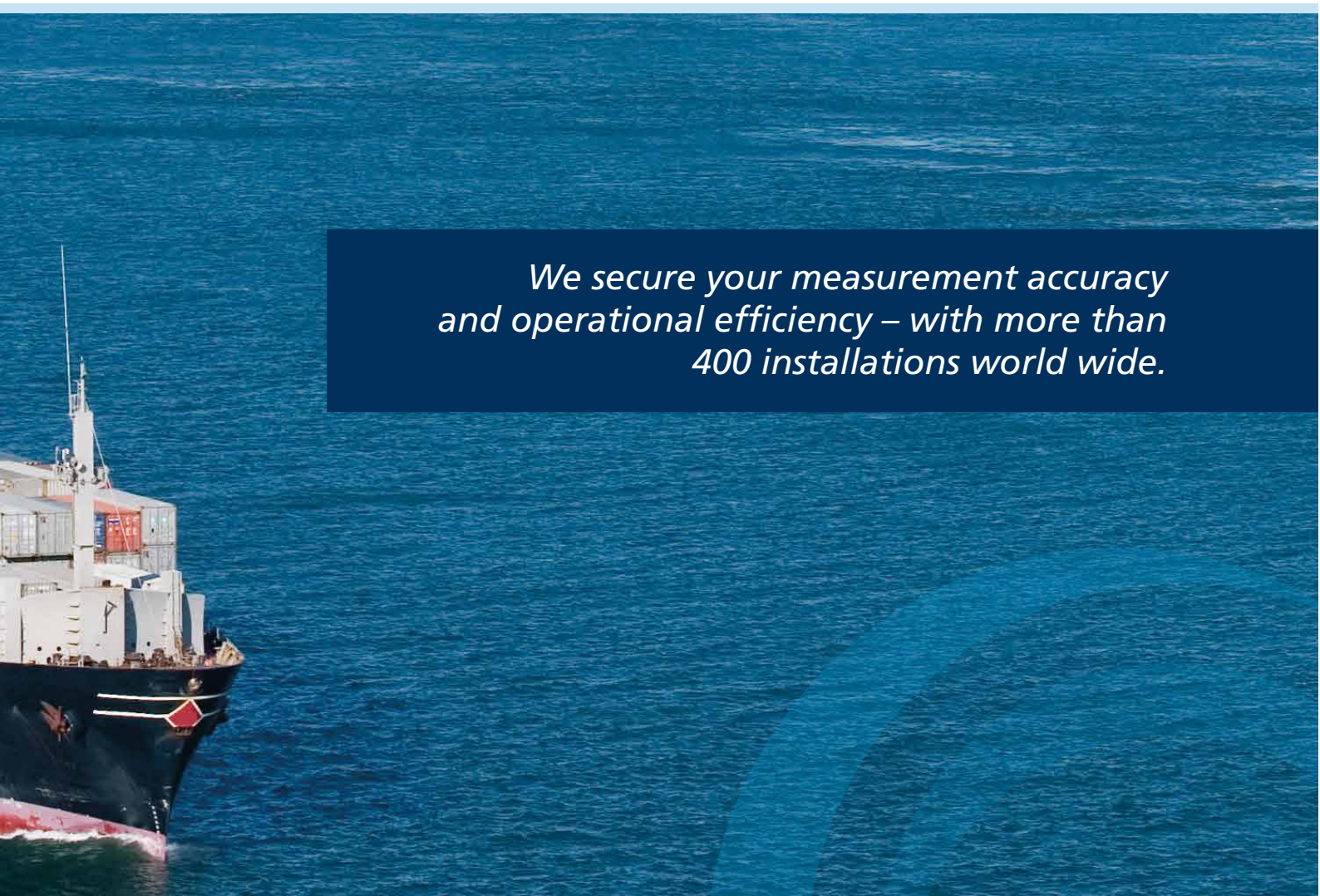

We secure your measurement accuracy and operational efficiency – with more than 400 installations world wide.

system will provide you with constant certainty of your emission levels. Measuring fuel consumption accurately and continuously is an obvious “low hanging fruit”.

Accuracy matters

How much fuel is consumed on board a ship, is directly related to the performance. The better the performance, the lower the fuel consumption during operation. In this equation accuracy is not negligible. An offset of 1% in measurement on a vessel operating 200 days a year consuming an average of 100 tons a day equals an offset of 200 tons a year. Depending on the price of HFO or MGO used, this misread has the potential to range up to USD 100,000. The Coriolis Mass Flow Meters used in our Fuel Consumption System has an accuracy better than 0,2% of nominal flow directly measured in mass, whereas most

volumetric flow meters are in the range 0,5% to 2,0% – and they rely on volumetric conversion which depends on the temperature to calculate a mass flow.

Know when you make money – and make more!

Without accurate measurements of the consumption of fuel on board, it is truly difficult to determine what effect any changes in installations, procedures or maintenance has had. Relying on either noon reports or measurement instrumentation of lower accuracy can make it very difficult to know the exact benefit of fuel saving projects – or at least delay the proof. Thus the installation of a Fuel Consumption System is a way to increase your competitive advantage by freeing your crew's hands from operation and maintenance of the instruments, which allows them to focus on their primary task: Optimizing the efficiency of the ship and thereby increasing profits.



How it works

The Fuel Consumption System lets the fuel consumption data work for you to increase crew awareness, consumption trending, maintenance planning, etc. It works by utilising a number of mass flow meters to measure the fuel consumption. The flow measurements are collected, logged and displayed on an operator interface, which can be placed where ever you need it.

Direct measurement of fuel efficiency

By installing one or more mass flow meters (depending on engine supply line layout and desired insight) fuel consumption can be monitored closely in real-time. The main principle is to measure the flow of fuel before and after the engine and/or generators. When you compare the consumption data with measurements of actual speed and position (based on speed log and GPS signals) you are able to directly measure the fuel efficiency.* If you require more detailed readings, additional flow meters can be installed, for example one set of meters per consumer or one set for the ship's entire consumption, further information is found on page 17.

Easy access to measured data

The measurements from the flow meters will be sent through Modbus signals to a collecting and processing cabinet with built-in or remote screen. Here the consumption will be calculated, displayed and logged. If you want the data sent to headquarters this requires the data link option which consists of two databases: One on board the ship and one at headquarters. Data will be sent

at the frequency chosen between the two databases. If the ship does not have an internet connection for a period of time, data will merely be stored and sent home once the connection is re-established.

Make the data work for you

Once the data is acquired and displayed use it to:

- Optimise operational efficiency by testing your trim tool
- Implement and maintain your SEEMP (Ship Energy Efficiency Management Plan)
- Create KPI's (Key Performance Indicators) for each voyage
- Evaluate improvement projects before fleet roll out
- Monitor the ship's consumption trend over time to improve your maintenance planning.

And most importantly let the crew get data insight to increase crew awareness as well as improving knowledge of operational performance.

* If you want measurement such as speed and position integrated you should take a look at our Performance Monitoring System.

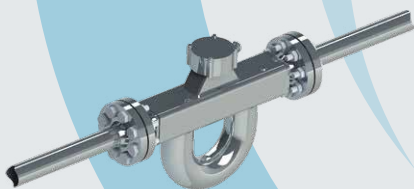

Coriolis mass flow meter

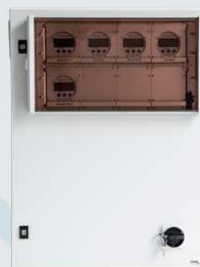

Control cabinet

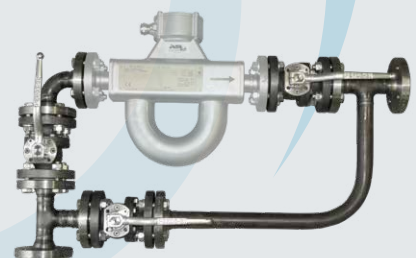

Bypass

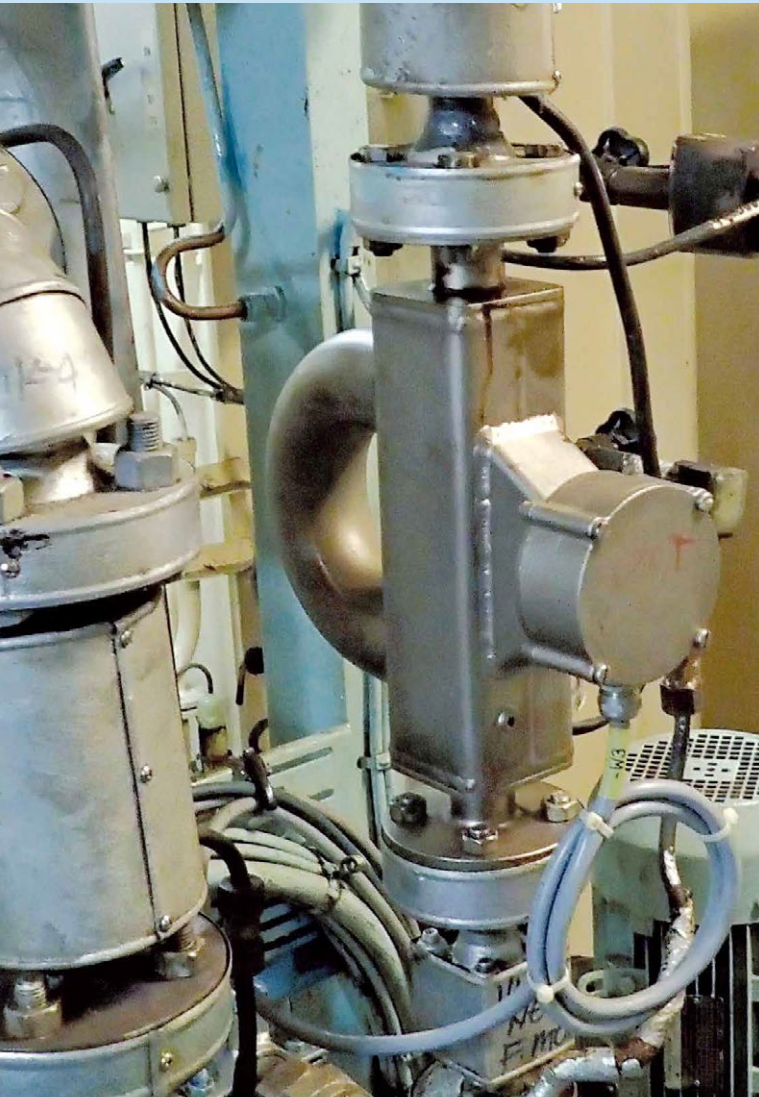

Easy read-out

The operator interface of the Fuel Consumption System is designed for easy reading. The user of the system will immediately get the relevant information they need as well as see the latest development in fuel consumption over time.

Operation



Once installed the Fuel Consumption System is easily operated. The operator panel can be placed in the engine room, engine control room or on the bridge, depending on your use or preference. The interface is intuitive and provides a fast overview of the different consumers, ensuring the crew gets the necessary information in order to take action.

A fully automated system

The Fuel Consumption System is fully automated and does not require any hands-on operation during normal conditions. The operator panel displays the measured consumption and has different options for showing data, but otherwise needs little attention.

System and data display matching your requirements

The data displayed depends on the system you choose to install, from the smallest system which simply shows the consumption of one or two consumer groups, to more extensive systems that display a large number of consumers. The system does not need any input or activation to run once it has been installed.

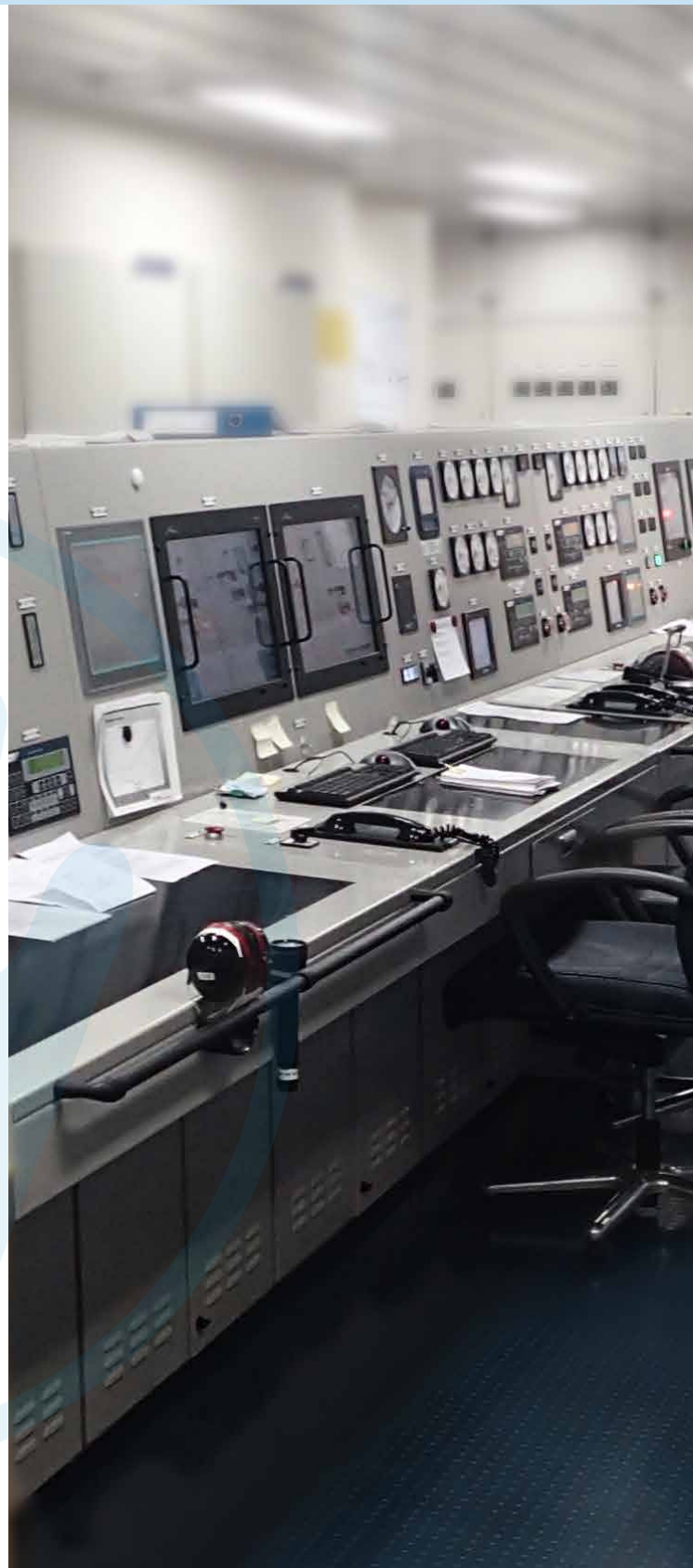

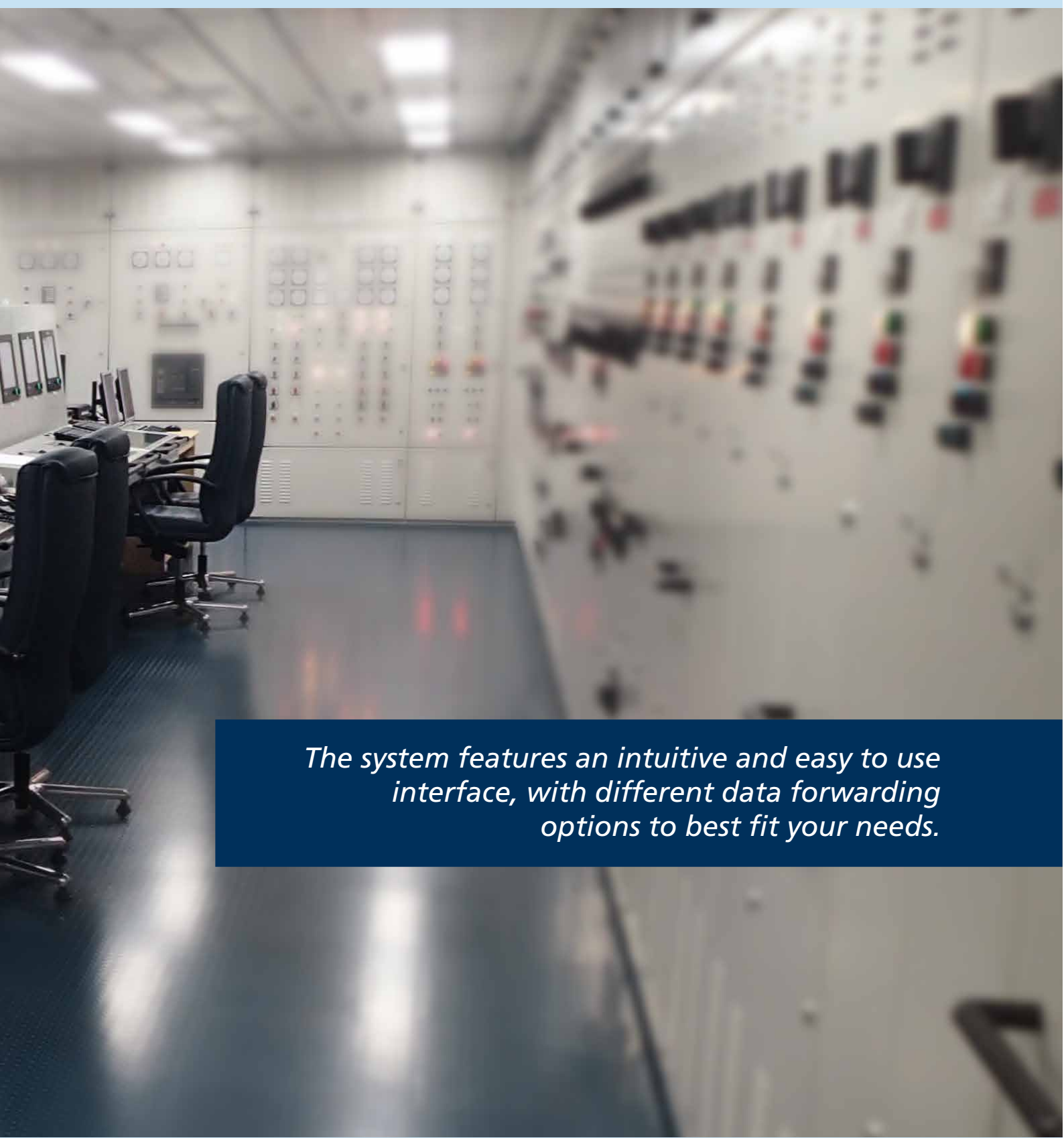

The system features an intuitive and easy to use interface, with different data forwarding options to best fit your needs.



Operation of interface



Get an easy overview or detailed readings of your immediate fuel consumption.

Main Engine Overview

The display of the main engine overview provides a total view of the main engine's fuel consumption. A consumption trend line shows an accumulation of the most recent data. The setup is dependent on the number of installed meters.

Main Engine

If you want a more detailed view, simply select a main engine from the overview screen. From here it is possible to get the actual and total consumption of the given engine, as well as values for engine inlet and outlet such as mass flow, volume, density, temperature and total mass.



Fuel Consumption in Detail



The Fuel Consumption System collects and logs data from flow meter(s), which provides your crew with a detailed consumption overview, depending on your preferences and requirements. Sending data to headquarters means choosing the optional data link, which makes use of the on board internet connection to send data from a database on board to one on shore.



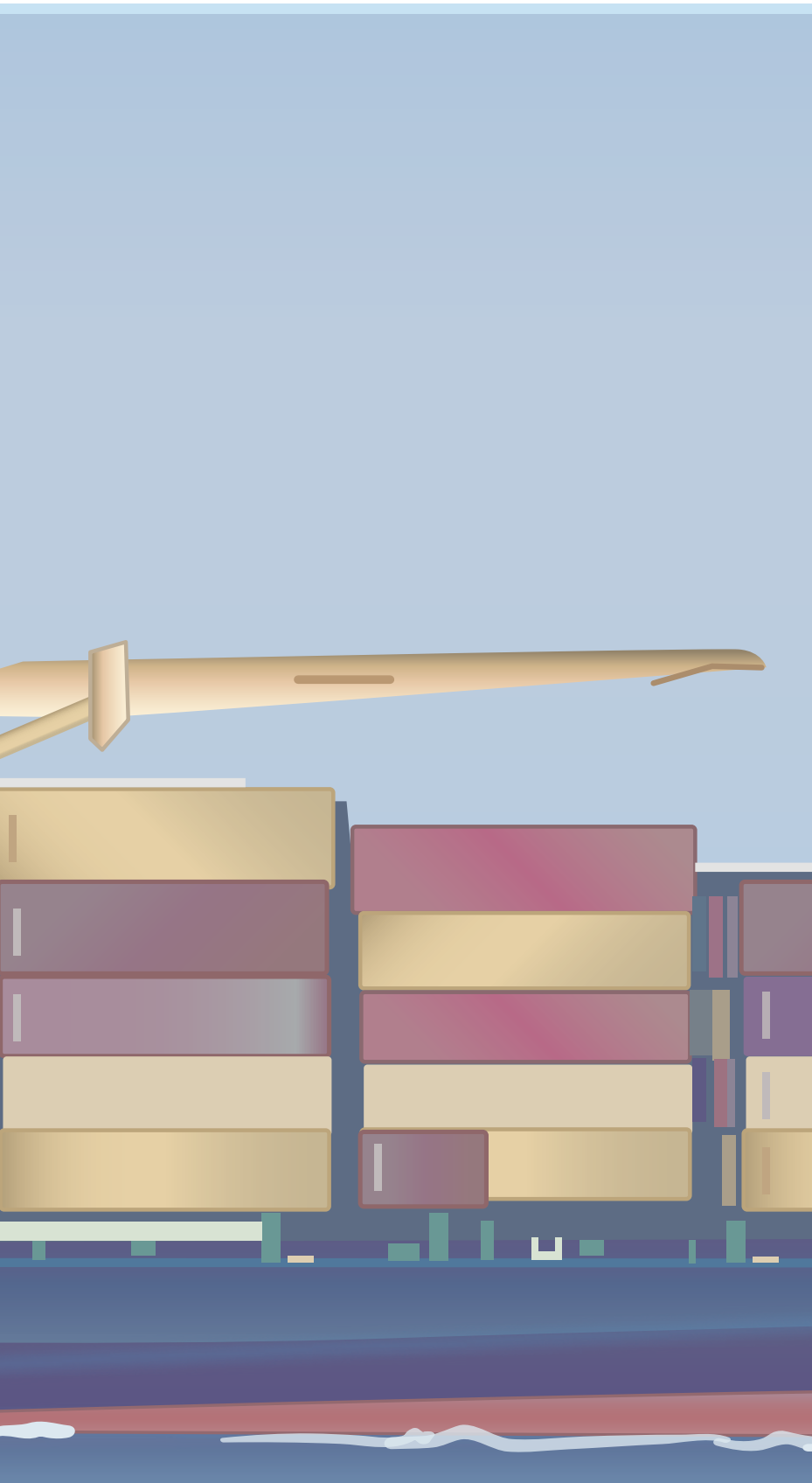

Data collected by the system

Engine control room



Panel

Shows all the data both collected and calculated. Can be installed in engine room, engine control room and bridge.



Ethernet

In order to send data to shore the system needs access to the internet.

Engine room



Flow Meter

Consumption (Main Engines, Auxiliary Engines and Boilers)



Cabinet

The cabinet functions as a central processing station which takes in signals as well as save them to the internal database

The performance concept

On board

3. Act



Performance Management System

- Same as Performance Monitoring System
- PLUS** Management tool
- PLUS** Data based predictions / help
- PLUS** Data entry for Voyage Numbering, Destinations, Anchoring, Mooring, Cargo and more...

2. Learn



Performance Monitoring System

- Same as Fuel Consumption System
- PLUS** Signals for Wind, Depth, Torque, Thrust, Draft, Rudder, Propeller, Motion Sensor and more...
- PLUS** Databases and Data Link

1. Measure



This is the system featured in this brochure.

Fuel Consumption System

- Real-time fuel measurement
- Data saved locally on memory card
- Optional database and Data Link

On board computer with database containing ship data.



Data Link

On shore

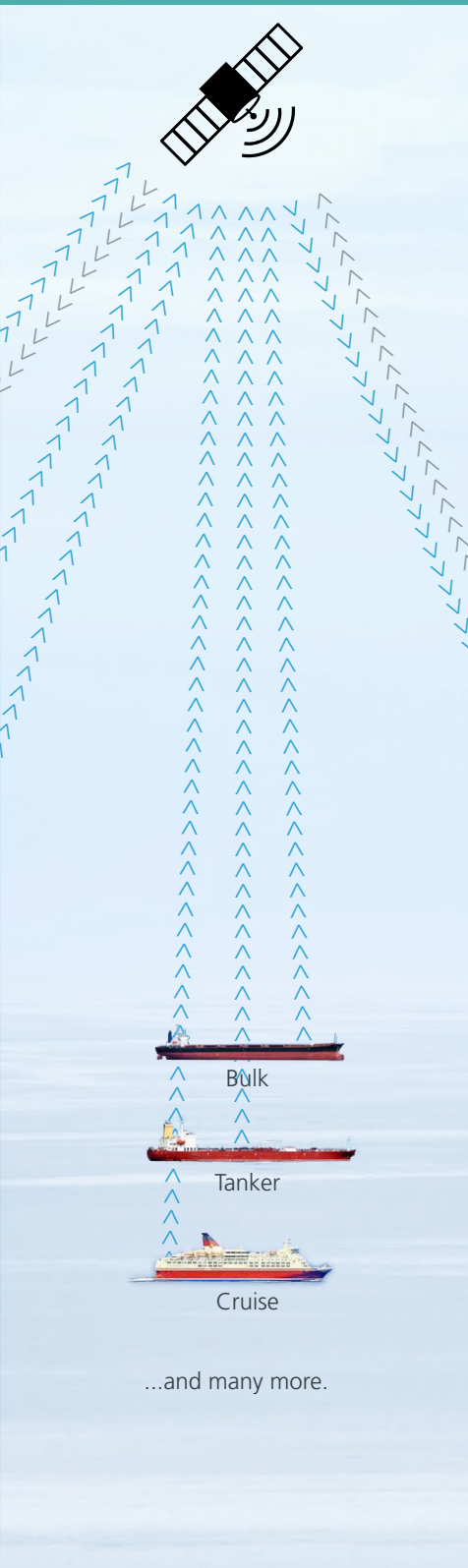

4. Manage

FleetViewer

- Access all your data on shore
- Help your captains optimize their voyage



On shore database with data from entire fleet connected to the system.

Our modular performance concept

Build your performance systems according to your company's needs – upgrade gradually.

1. Fuel Consumption System

The entry model to the performance concept. Start with basic measuring and get knowledge of your fuel consumption.

2. Performance Monitoring System

Get more sophisticated insight into your vessel's performance by adding bridge and engine room data to the system.

3. Performance Management System

Ease management decision making on board by getting performance predictions based on current data, weather and next voyage.

4. FleetViewer

Get the complete overview of your fleet's performance and consumption, and use it to optimize in large scale.

Data Link

The database on board sends data to shore. In case of no connection, the accumulated data will be sent when back online.



Installation setup

As the cost of operating a vessel typically is within the range of 50% to 70% of the total OPEX, consumption monitoring is an efficient way of getting an insight into how spending is utilised on board. The measurement can be done in different ways with different levels of insight.

Coriolis flow meter RCCS34

Flow	MGO	HFO
Circulated Flow Min.	0,275 m ³ /h	0,21 m ³ /h
Circulated Flow Max.	2,750 m ³ /h	2,10 m ³ /h
Consumption Min.	0,092 m ³ /h	0,07 m ³ /h
Consumption Max.	0,920 m ³ /h	0,70 m ³ /h

Coriolis flow meter RCCS36

Flow	MGO	HFO
Circulated Flow Min.	1,02 m ³ /h	0,820 m ³ /h
Circulated Flow Max.	10,20 m ³ /h	8,20 m ³ /h
Consumption Min.	0,34 m ³ /h	0,273 m ³ /h
Consumption Max.	3,40 m ³ /h	2,730 m ³ /h

Coriolis flow meter RCCS38

Flow	MGO	HFO
Circulated Flow Min.	3,0 m ³ /h	2,73 m ³ /h
Circulated Flow Max.	30,0 m ³ /h	27,30 m ³ /h
Consumption Min.	1,0 m ³ /h	0,91 m ³ /h
Consumption Max.	10,0 m ³ /h	9,10 m ³ /h

1-meter setup

The simplest way of measuring fuel consumption is by installing a single flow meter, which measures the fuel transferred from the fuel tank to the settling tank. The level of fuel in the settling tank is typically maintained by level sensors, and therefore the flow to the settling tank is equal to what is consumed.

3-meter setup

If more detailed monitoring is desired, then a 3-meter setup can be introduced. With the 3-meter system, the total fuel consumption is monitored by flow from fuel tank to settling tank. A set of flow meters, installed on the common auxiliary fuel supply line and return line, will provide the total consumption measurement of the auxiliary engines. By subtraction, the main engine fuel consumption can be calculated. By splitting the main engine and the auxiliary engines, the crew on board as well as on shore has a much more detailed overview of how the consumers perform.

Full consumer insight

To gain full understanding of the fuel consumption, you measure on each consumer inlet and outlet. This will provide a complete insight into each consumer's fuel consumption, and any deviations from performance expectations or norms, can easily be pinpointed. This can potentially aid in preventative maintenance planning and better utilisation of auxiliary engines.

Your own setup

Insatech Marine is not restricted regarding installations. Therefore if you have your own specific setup that you would prefer, we can accommodate a corresponding setup or install the system on existing flow meters. In such cases we will typically include an engine pre-inspection to ensure technical feasibility of the setup.



◀ **The flow ranges are calculated under the following conditions:**
 HFO: 985 kg/m³, 12 cSt, 1 bar pressure loss at circulated max flow.
 MGO: 895 kg/m³, 8 cSt, 1 bar pressure loss at circulated max flow.

1-meter setup

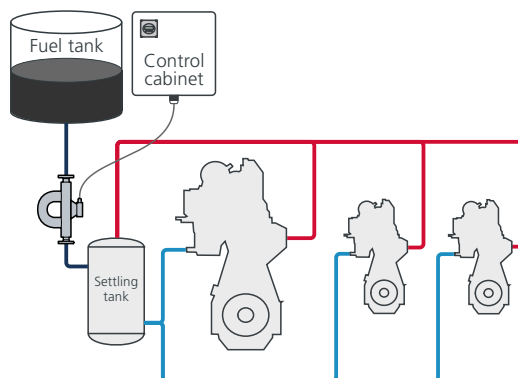

3-meter setup

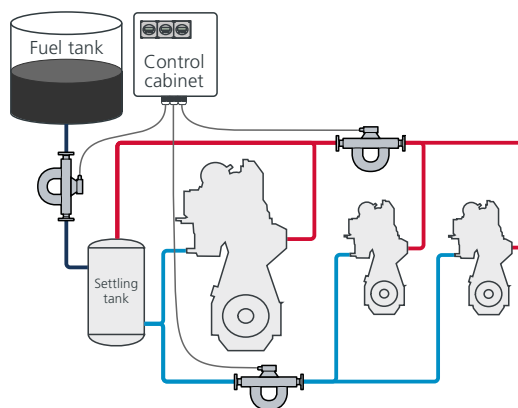

Full measurement setup

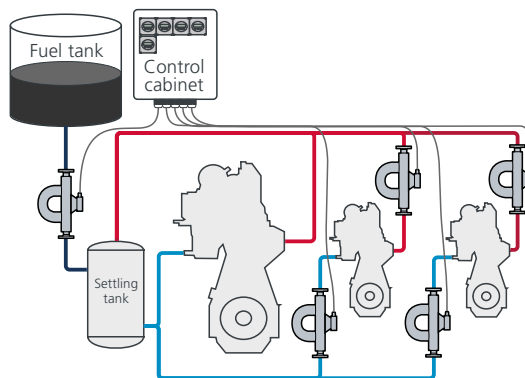

- Main supply line
- Feed line
- Return line
- Flow meter



Installation

The system installation does not inflict you with unnecessary costs, it will not alter your schedule or put your vessel out of service. Our experienced technicians install and commission the system while you are in service, whether at sea, in port or dry dock. We are ready to move out at your preferred destination and time.

Do it yourself – or let us install

The system is programmed, calibrated and has been initially setup by our technician to minimize installation time on board. The crew on board will in some cases be able to install the equipment under the guidance of Insatech Marine's technicians to ensure correct placement and electrical

installation. This minimizes costs and required man-hours, while ensuring maximum benefit of the system during use. However, we are also able to provide installation with commissioning, tests and training of the crew. We complete the installation at sea, in port or dry dock at your preference.

At sea



In port



In dry dock



*Turnkey solutions and installations;
at sea, in port or dry dock at your preference.*

Service maintenance and support

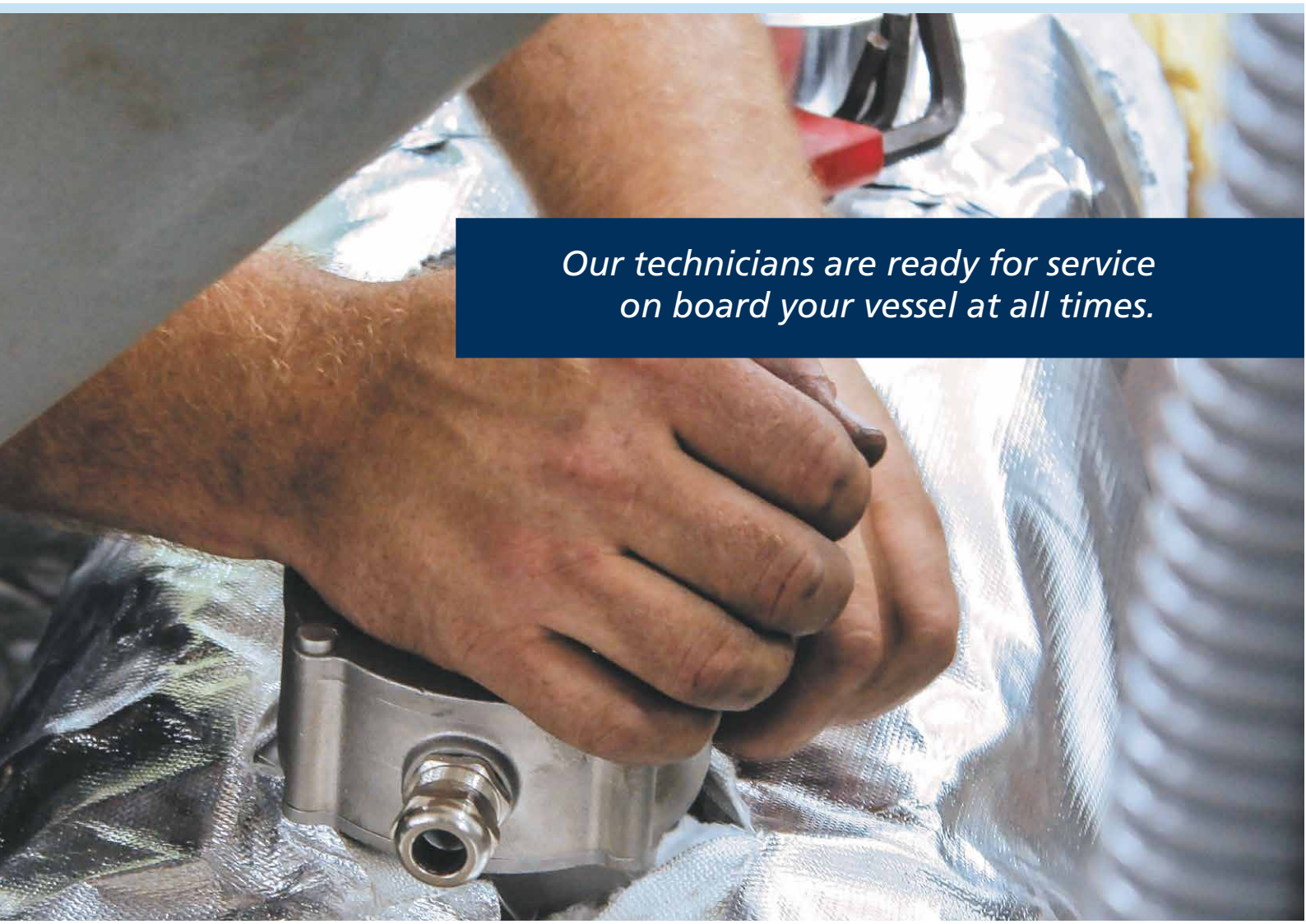

Our technicians are ready for service on board your vessel at all times.

If you require a service agreement as part of the system our skilled technicians are ready to service your vessel at all times. While the system requires minimal maintenance an occasional calibration of equipment is recommended.

Service and support is readily accessible

To constantly get highly accurate measurements, your marine equipment must function optimally. This means it must be calibrated according to its purpose and therefore we provide service options, should the need arise. This is why Insatech Marine has our own technicians ready for service on board your vessel at all times, whether it is a planned service visit or a pressing and acute matter that needs immediate attention.

Minimal maintenance required

As the equipment used for the Fuel consumption System is mostly constituted by components without moving parts, the need for active maintenance is minimal. Nonetheless there might be equipment in need of calibration or service from time to time, and depending on the specific setup, a service and maintenance plan will be issued with each individual Fuel Consumption System.

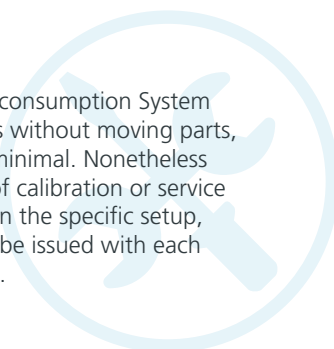

What we do



Below is a short recap of our different solutions. Our performance concept can be entered at your preferred stage depending on the level of insight and sophistication wanted. We can also help you out with ODME and bunker systems. All systems can be delivered as turnkey solutions.

Performance Monitoring System

The system provides an overview of the ships performance, based on direct on-line measurements. It is versatile and can be customized according to any measurements that you would like to monitor. Fuel consumption is measured with high accuracy mass flow meters, together with propeller shaft torque and rpm. For generators a power meter will be installed, and motion sensors are used to indicate weather conditions. This gives not only valuable information about fuel consumption, but also KPI values as g/kWh & g/Nm.

Performance Management System

When fully developed it will become an upgraded version of the Performance Monitoring System and complete the on board management layer of the performance concept. It is decision making oriented and an open input based concept, where more factors are taken into account when evaluating the ships performance. All factors taken into the system are converted into KPI's. The crew will experience a tool that effectively allows them to contribute to a more cost effective operation.

Fleet Viewer

When fully developed it will become a system for visualizing and creating an overview of fleet performance. It enables comparisons, voyage statistics, KPI generation via consumption, performance and maintenance planning. As such it is a tool for the headquarter to plan, optimize and manage the fleet. The system is built on top of the Performance Monitoring System.

Bunker Management System

Is a Coriolis Mass Flow Meter-based Bunker Management System with a highly accurate and volume insensitive measurement of transferred bunker. The system ensures an efficient bunker operation and is a pro-active tool to ensure you get the amount of bunker you pay for.

ODME Systems/15 PPM Bilge alarm

By regulations under MARPOL, all vessels must be equipped with a system for Bilge Water Discharge Monitoring as well as Oil Discharge Monitoring and Control Equipment (ODME). Both systems monitor the oil content of ballast water discharged over board and control the discharge allowance based on whether the level of oil content is below the set limits.

A trustworthy and competent partner

Insatech Marine offers field-tested and proven solutions that meet international rules and regulations as well as helping you save money. We provide comprehensive installation, commissioning, training, service and maintenance to ensure you as little downtime as possible.

Insatech was established in 1989, and has since then grown to +70 employees. With more than 25 years of experience in the field of automation and instrumentation we are a strong partner for both our customers and suppliers. As a result of our longstanding partnerships with some of the world's leading manufacturers within instrumentation and automation, we are able to provide you with global service.

Our system users include:





Our international agent network

In order to provide the best possible customer support Insatech Marine works closely together with selected agents. This network of dedicated agents will help to ensure your positive experience with our systems and support functions. The agent network will be developed continuously to serve you locally wherever you may operate.

Croatia

Oreco
nenad@oreco.hr
www.oreco.hr

Cyprus

Interglobe Marinet Services
g.savvides@interglobe.com.cy
www.interglobe.com.cy

Estonia

R-Automation
rommi@r-automation.ee
www.r-automation.ee

Finland

Septor Oy
fredrik.bjorklof@septor.fi
www.septor.fi

Germany

Christian Bindemann Marine Consulting
consulting@mkecb.com
www.mkecb.com

Greece

OCEANKING Technical & Trading S.A
p.pollalis@oceanking.gr
www.oceanking.gr

India / Singapore

Marine Mechanics
technical@marinemechanics.biz
www.marinemechanics.biz

Italy / Monaco

AdrianaVal
garbelli@adrianaVal.it

Latvia

BAS-Automation
info@basa.lv

Netherlands

Theunissen Technical trading
h.volmerink@tttbv.nl
www.tttbv.nl

Norway

Scanvi Interyards
tarald.hoy@scanvi-interyards.no
www.scanvi-interyards.no

Poland

Trent
office@trent.com.pl
www.trent.com.pl

Romania

s. c. Technoind s.r.l.
puiu.maris@technoind.ro
www.technoind.ro

Sweden

Energy Survey & Solutions enysson AB
lars-erik.hellring@enysson.com
www.enysson.com

Thailand

Contrologic Co. Ltd
siravich@contrologic.co.th
www.contrologic.co.th

Turkey

Esko Marine
eesinduy@eskomarine.com.tr
www.eskomarine.com.tr

UK

Marine Marketing Services
info@marinemarketingservices.co.uk
www.marinemarketingservices.co.uk

United Arab Emirates

Technology Ventures
vijai.v@tv-me.com
www.tv-me.com

USA

Rainier Trading dba Rainier Marine
oakley@rainier-marine.com





Customer support at your preferred destination.





*Increase your competitive advantage
by reducing costs via
performance and efficiency
improvements on your vessels.*

MARINE



Theunissen Technical Trading BV | Postbus 70, 6580 AB Malden, Nederland
T +31(0)24 358 44 55 | F +31(0)24 358 21 66 | info@tttbv.nl | www.tttbv.nl

This is a series of information booklets produced by Insatech Marine. Other booklets can be found at www.insatechmarine.com. The folder is printed on FSC-certified paper.

FSC is an international certification scheme for tree and paper. In FSC forests no more trees are utilized than what can be reproduced. FSC is a guarantee of the protection of wildlife and vegetation, and an assurance that forest workers are secured in terms of education, occupational security and salary.

© Insatech A/S
Reproduction of text or excerpts of this is authorized provided the source is acknowledged.