

Fire alarm central Salwico Workboat CE

Part no. 5102013-02A



General description

Salwico Workboat CE is a conventional fire detection system with 8 fire detector sections SOLAS compliant. Tested and certified by all major classification societies, this system provides an optimal fire detection solution for smaller vessels.

The system is managed and supervised through Control Panel M 4.3. The Control Panel M 4.3 is mounted separately from the fire alarm cabinet.

The central is delivered complete with:

- 1 x Control panel M 4.3, External
- 2 x Power supply AC/DC 2.5A (A 24 VDC kit can be ordered separately).
- 1 x I/O 70, for 8 conventional sections
- 8 pre-configured powered outputs 24 VDC. (Max. consumption 1.8 A)
- Batteries 24V, 1,3Ah
- Optional serial interface (NMEA)

The cabinet is for wall mounting. The control panel can be flush or wall mounted.

One multi flange for cable inlet is included in the delivery.

Data

Nominal voltage	100-240VAC
Power consumption	~10W in normal condition
Heat emission	~25 Kcal/h
Ingress Protection	IP32
Cable terminals	2.5mm ²
Temperature range	-5°C to +55°C
Material, cabinet	Steel
Colour, cabinet	RAL7035
Weight	~10,5 kg

Related Parts

5100088-00A	PSU M DC/DC 5A
5102024-00A	Relay Kit Workboat

Wall mounted cabinet dimensions (mm)

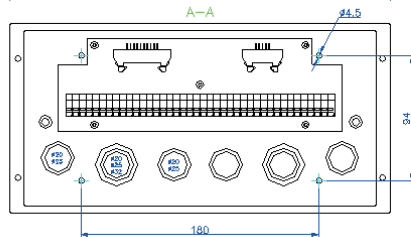
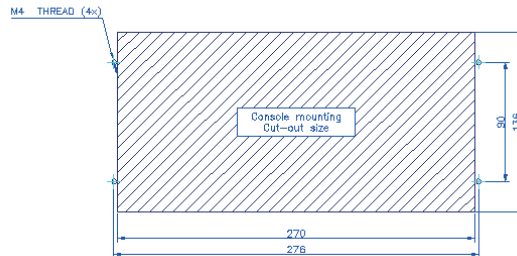
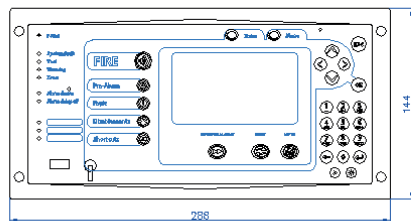
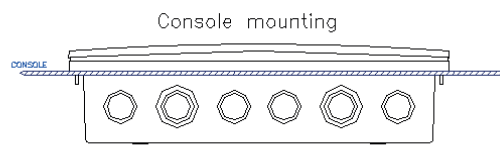
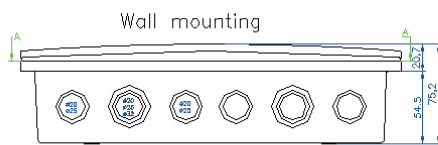
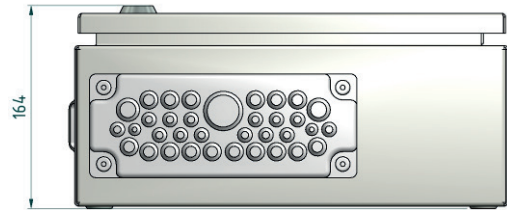
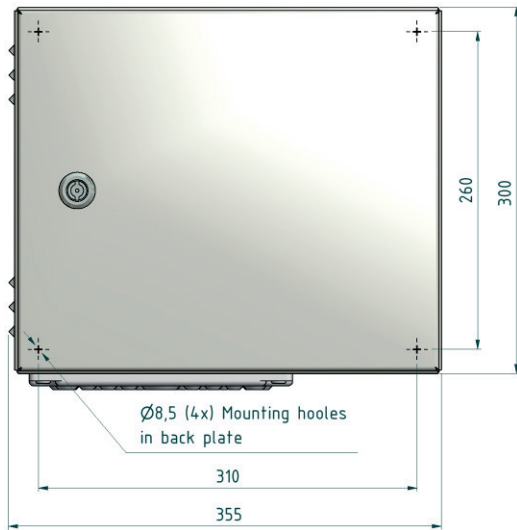

Knock-outs diameters.
 12 x Ø20 (6 from behind)
 12 x Ø25 (6 from behind)
 4 x Ø32 (2 from behind)

Colour: Black
 Weight: Complete unit ~1.25 kg

Power Supply Connection:

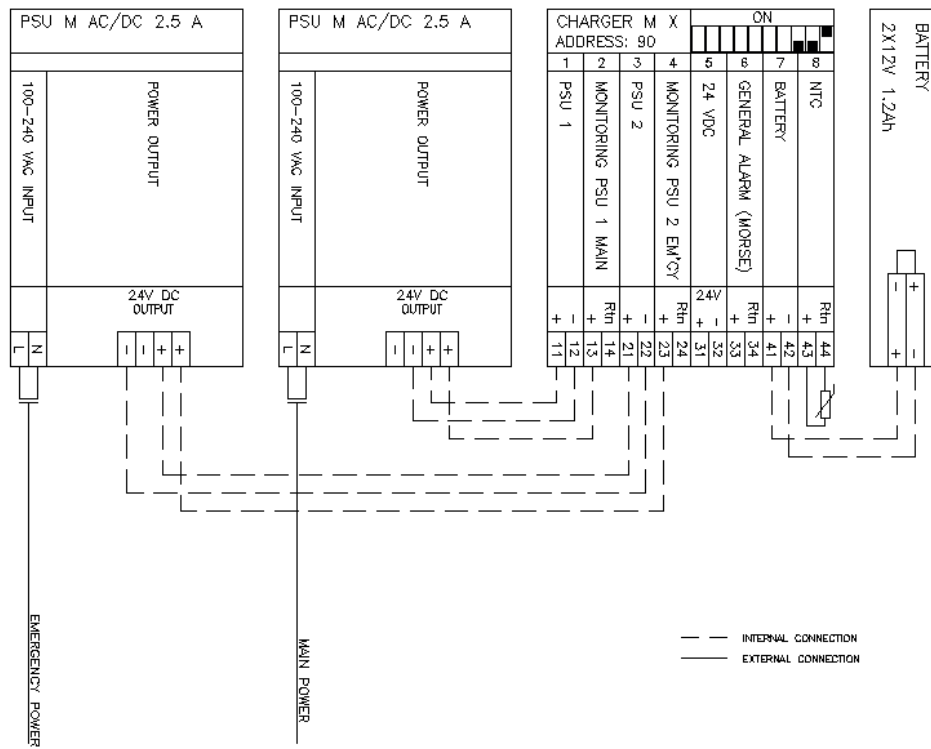

NOTE:

If external DC power source is used this must be adjusted to 28.5V. A separate DC/DC kit is available in case this requirement can't be fulfilled.

Equipment Connections

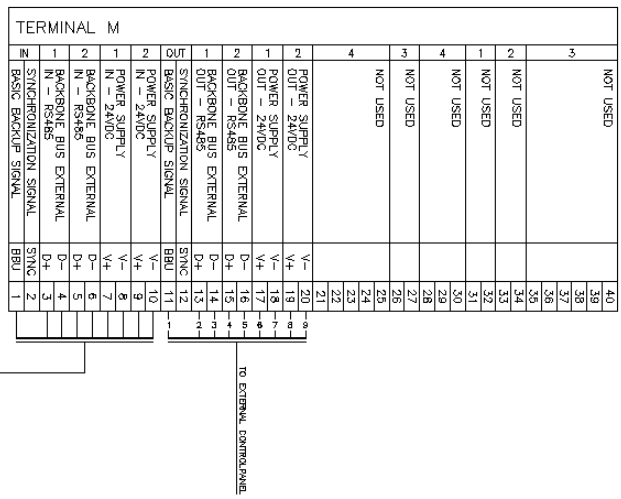
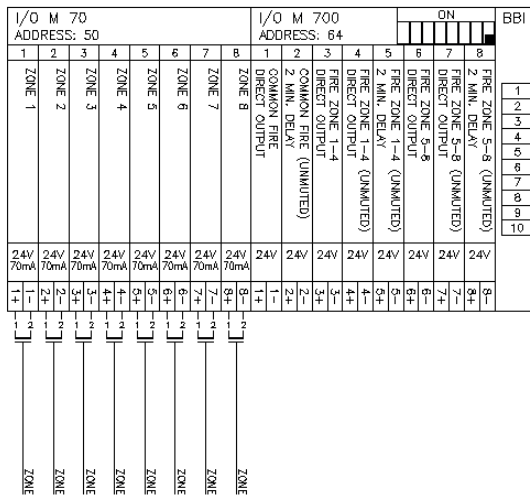

External control panel:

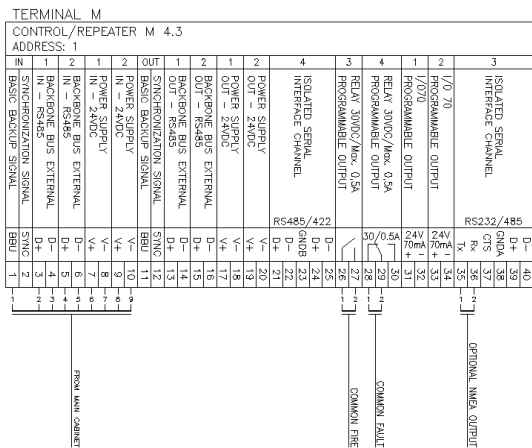

Optional relay kit connections:

